

RITE-TEMP MFG.

MODEL: RTH-503 SPEC

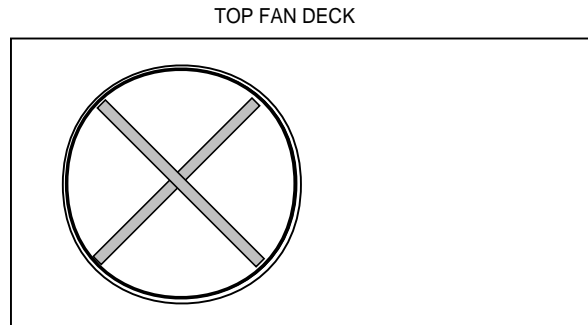
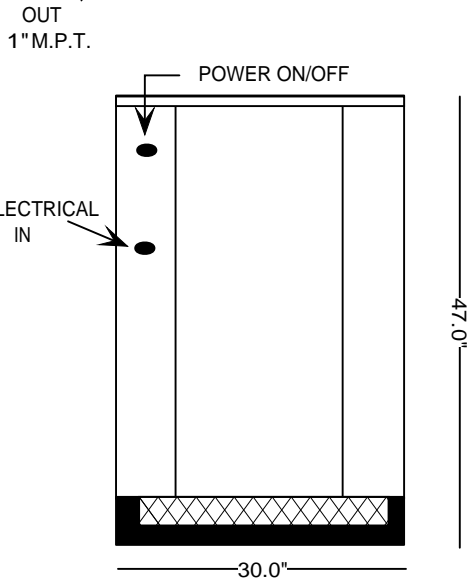
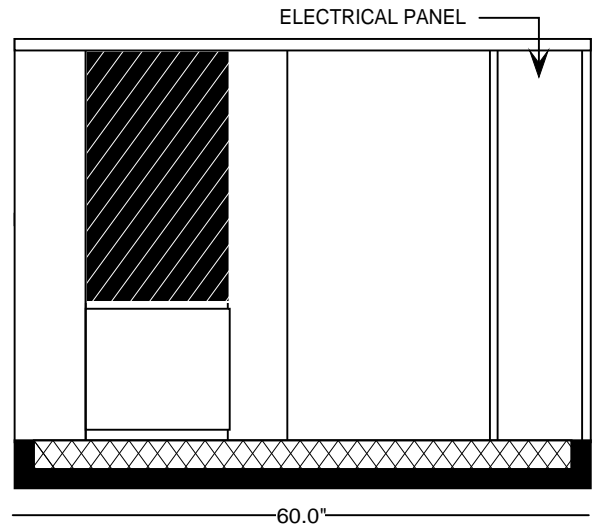
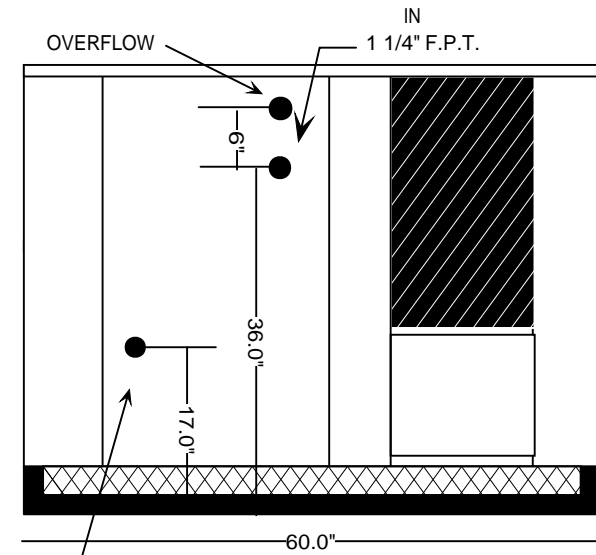

SPECIFICATIONS:

- 60,000 BTU/HR heat removal - 95F degree ambient, 45F degree water out.
- Electrical: 208-230 / 60HZ / 3 PH 24 volt electrical panel.
- Run Load: 31.4 Amps.
- Minimum Circuit Ampacity: 37; Maximum Circuit Ampacity: 67.
- ETL Laboratory Approved: ETL # 63122 & CANCSA NO. 236
- 40 gallon, 16 gage, 304 stainless steel closed evaporator tank with coil inside.
- 1 HP water pump: 25 - 30 GPM, 30 - 35 PSI.
- Low ambient start-up package (standard).
- R422D Refrigerant.
- Analog water temperature and pressure gauges.
- Air-cooled condenser.
- Cabinet: 18 and 20 gage Phos coat galvanized steel finished with polyester powder coat.
- Base frame: 1/8 - inch angle & channel iron.
- Compressor: Copeland Hermetic (5 - year warranty).
- Approximate crated weight: 700 LBS.
- Physical dimensions: 30" wide, 60" long, and 47" tall.